

CLOCK-Gen

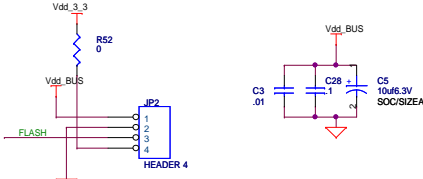

Power

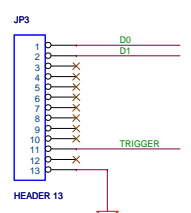
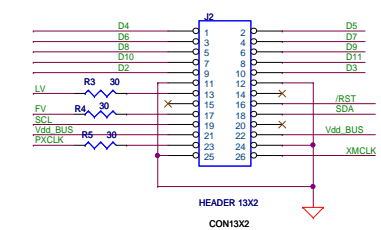
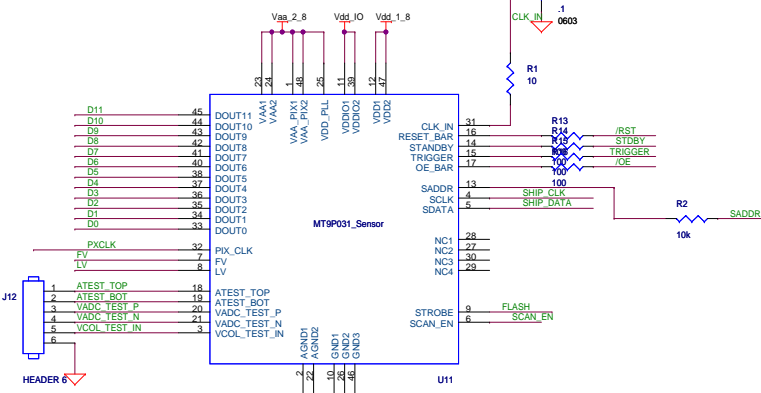
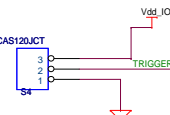
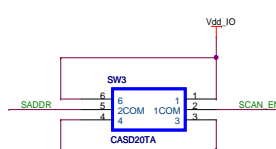
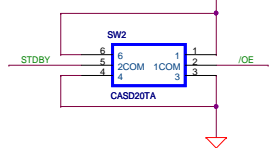
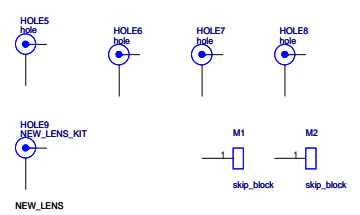
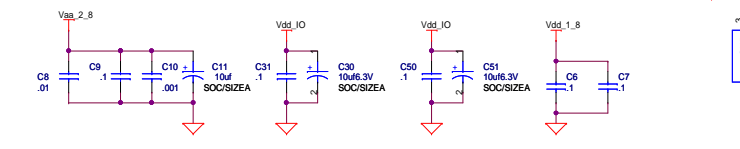
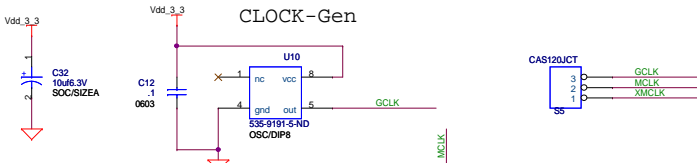
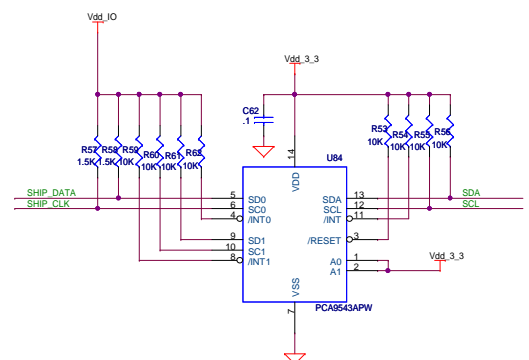
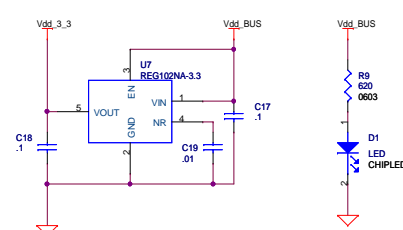
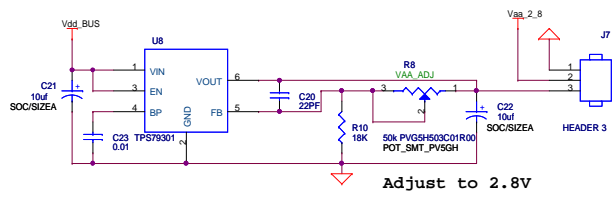
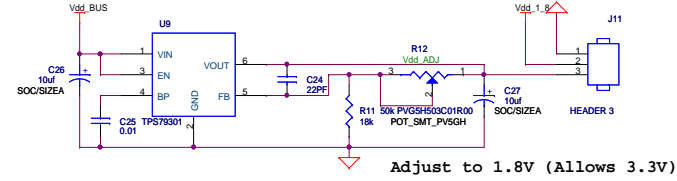
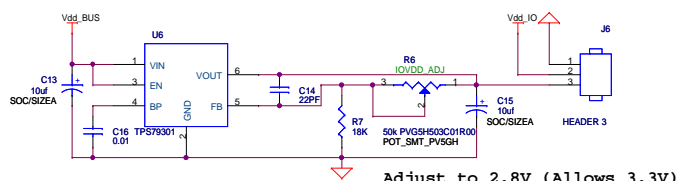

File	MT9P031 HEAD BOARD		
Size	Document Number		Rev 1R
C			
Date:	Thursday, October 25, 2007	Sheet	1 of 1

Micron Technology, Inc., reserves the right to change products or specifications without notice.
©2007 Micron Technology, Inc. All rights reserved.